

DEVIATORE CERAMICO 3 VIE: 1 ENTRATA, 2 USCITE CON OFF

3 WAYS CERAMIC DIVERTER: 1 ENTRY, 2 EXITS WITH OFF

3-WEGE KERAMIK-UMSTELLVENTIL, 1 EINGANG, 2 AUSGÄNGE MIT OFF

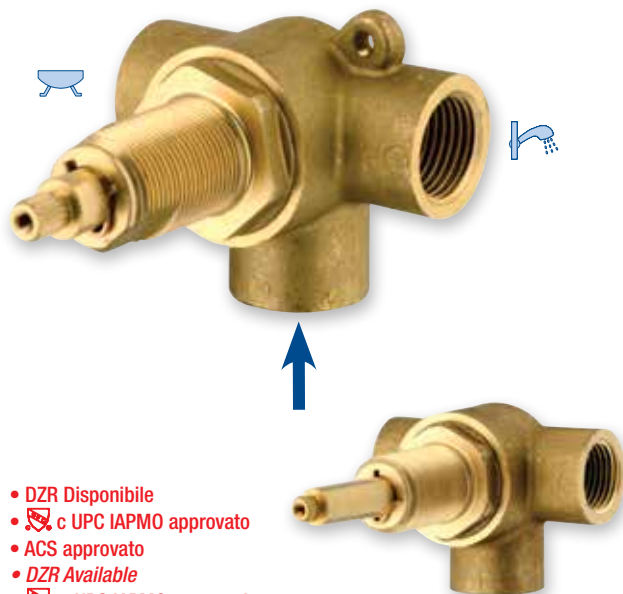

- DZR Disponibile
- c UPC IAPMO approvato
- ACS approvato
- DZR Available
- c UPC IAPMO approved
- ACS approved
- DZR erhältlich
- c UPC IAPMO geprüft
- ACS geprüft

Art. 2205CA

Deviatore ceramico 1 entrata + 2 uscite
+ OFF rotazione 180° con alette fissaggio
Ceramic diverter 1 entry + 2 exits
+ OFF position 180° rotation with fixing system
Keramik-Umstellventil 1 Eingang + 2 Ausgänge
+ OFF mit einer Rotation um 180° und mit Befestigungsrippen

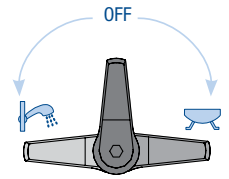

Art. 2205

SENZA alette fissaggio
WITHOUT fixing system
OHNE Befestigungsrippen

Art. 2205CA S/F

con rotazione 360°
with 360° rotation
mit einer Rotation um 360°

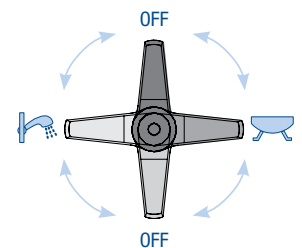

Art. 2205S/F

con rotazione 360° SENZA alette fissaggio
with 360° rotation WITHOUT fixing system
mit einer Rotation um 360° OHNE Befestigungsrippen

X	Y
73,5	BR. Ø 7,65 x Z=20 BR. Ø 8 x Z=24
82	BR. Ø 7,65 x Z=20 BR. Ø 8 x Z=24
95	BR. Ø 7,65 x Z=20 BR. Ø 8 x Z=24
110	BR. Ø 7,65 x Z=20 BR. Ø 8 x Z=24



Diagramma di portata (uscita libera)
Flow diagram (free exit)
Diagramm der Durchflussleistung (freier Ausgang)



ACCESSORI / ACCESSORIES / ZUBEHÖRTEILE

Art. 00120

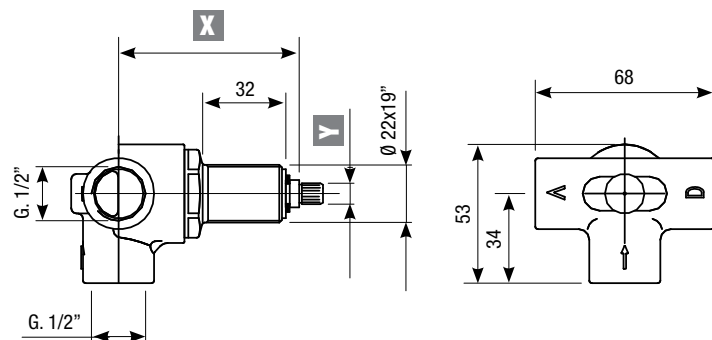
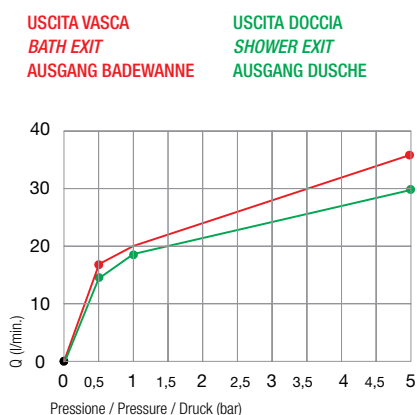
Maniglia deviatore
Diverter handle
Umstellgriff

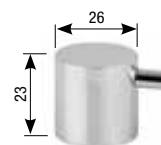

Art. 00080

Coprifiletto deviatore cromato
Diverter cover thread
Verchromte Gewindeabdeckung für das Umstellventil



Adattatore
Ring adaptor
Adaptor

Art. 2501 Ø 26X19"

Art. 2502 Ø 27X19"

Art. 2504 G.3/4"

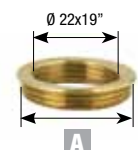

Art. PR22/19

Protezione coprifiletto
Thread protection
Gewindeabdeckungsschutz

