

# INCASSO VASCA CON PIASTRA, SCATOLA DI PROTEZIONE, SUPPORTO DOCCIA E DEVIATORE

CONCEALED BATH MIXER WITH PLATE, PROTECTION BOX, SHOWER BRACKET AND DIVERTER

EINBAUBADEWANNE MIT PLATTE, SCHUTZGEHÄUSE, DUSCHHALTERUNG UND UMSTELLVENTIL



## Art. 800

Verisone tonda  
Round version  
Runde Ausführung

### ACCESSORI / ACCESSORIES / ZUBEHÖRTEILE

#### Art. 1113

Anello sede cartuccia  
Cartridge ring seat  
Kartuschenringsitz



#### Art. 1000

Riduttore per cartuccia Ø 35 ABS  
Cartridge reduction Ø 35  
ABS-Kartuschenverminderung Ø 35



#### Art. 2905SF

Deviatore 2 vie bordovasca automatico  
Deck diverter 2 ways automatic  
Automatisches 2-Wege-Umstellventil  
für Wannenrandarmaturen

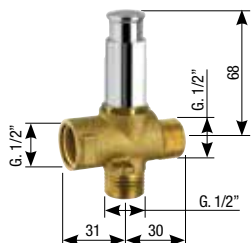

#### Art. 1174

Corpo miscelatore  
lavabo da incasso  
Concealed basin mixer  
body only  
Mischbatterie-Einbaukörper  
für Waschtische

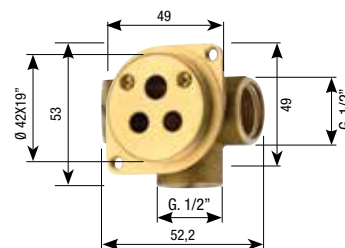

#### Art. 1003SF

Cappuccio ABS  
ABS cap  
ABS-Kappe

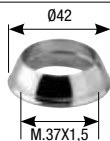

#### Art. 2006

Anello fissaggio  
Fixing ring  
Haltering



#### Art. 1004BS

Ghiera  
Ring nut  
Gewindehülse



#### Art. 801

Scatola incasso  
fissaggio L.330  
Concealed fixing box L.330  
Gehäuse für die  
Einbaubefestigung L.330

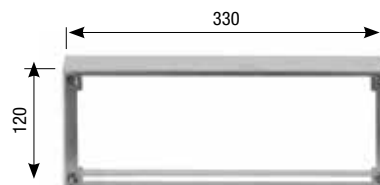

#### Art. 269

Supporto doccia  
Shower holder  
Duschhalterung

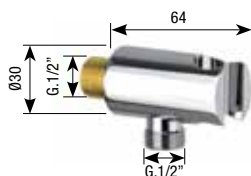

#### Art. 804

Piastra 340x130x2  
Plate 340x130x2  
Platte aus Chrom 340x130x2

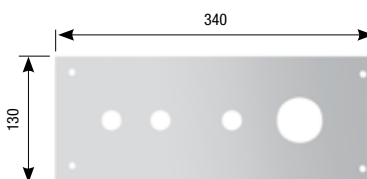

#### Art. 340

Bocca  
Spout  
Auslauf

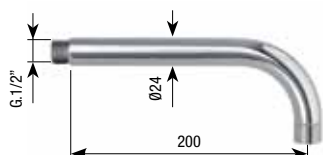

#### Art. 808

Tappo coprivite  
Screw cover  
Schraubenabdeckungsstopfen



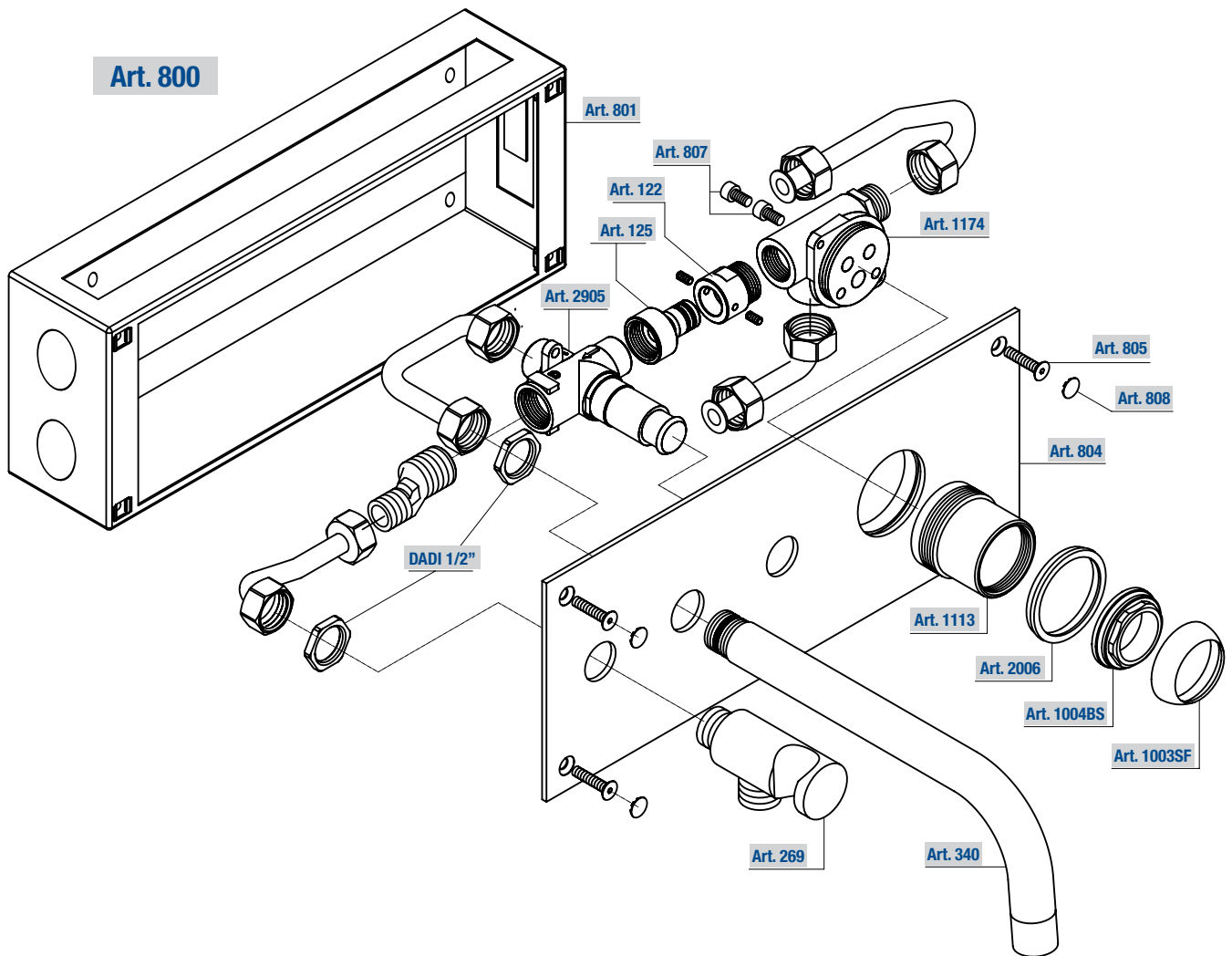

**SCHEMA CONSIGLIATO PER L'INSTALLAZIONE**  
**INSTALLATION SCHEME**  
**INSTALLATIONSANWEISUNG**

