

INCASSO DOCCIA CON PIASTRA, SCATOLA DI PROTEZIONE, SUPPORTO DOCCIA E DEVIATORE

CONCEALED SHOWER MIXER WITH PLATE, PROTECTION BOX, SHOWER BRACKET AND DIVERTER

EINBAUDUSCHE MIT PLATTE, SCHUTZGEHÄUSE, DUSCHHALTERUNG UND UMSTELLVENTIL



Art. 830

Verisone tonda
Round version
Runde Ausführung

ACCESSORI / ACCESSORIES / ZUBEHÖRTEILE

Art. 1113

Anello sede cartuccia
Cartridge ring seat
Kartuschenringsitz



Art. 2905SF

Deviatore 2 vie bordovasca automatico
Deck diverter 2 ways automatic
Automatisches 2-Wege-Umstellventil für Wannenrandarmaturen

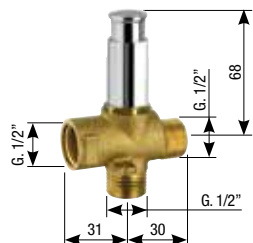

Art. 1003SF

Cappuccio ABS
ABS cap
ABS-Kappe

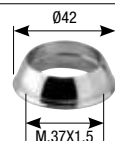

Art. 1004BS

Ghiera
Ring nut
Gewindehülse



Art. 269

Supporto doccia
Shower holder
Duschhalterung

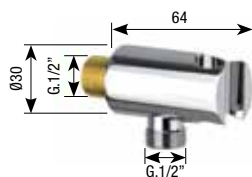

Art. 1000

Riduttore per cartuccia Ø 35 ABS
Cartridge reduction Ø 35
ABS-Kartuschenverminderung Ø 35



Art. 1174

Corpo miscelatore lavabo da incasso
Concealed basin mixer
body only
Mischbatterie-Einbaukörper für Waschtische

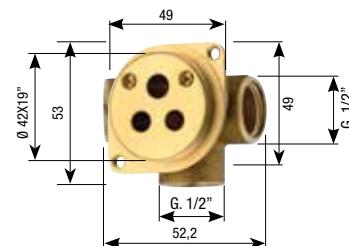

Art. 2006

Anello fissaggio
Fixing ring
Haltering



Art. 801

Scatola incasso fissaggio L.330
Concealed fixing box L.330
Gehäuse für die Einbaubefestigung L.330

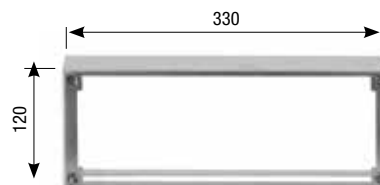

Art. 824

Piastra 340x130x2
Plate 340x130x2
Platte aus Chrom 340x130x2

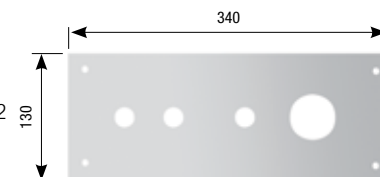

Art. 808

Tappo coprivite
Screw cover
Schraubenabdeckungsstopfen



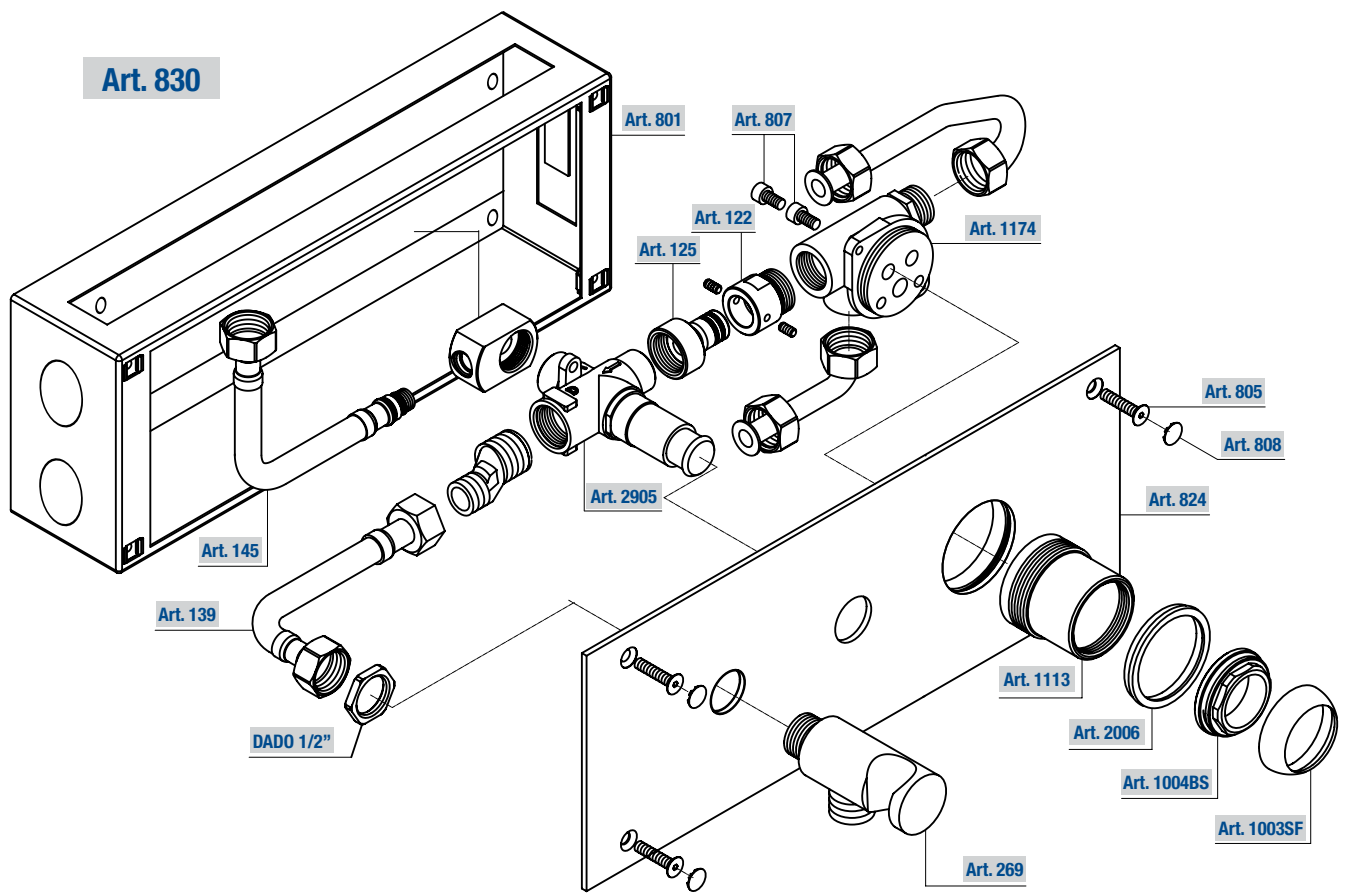

SCHEMA CONSIGLIATO PER L'INSTALLAZIONE
INSTALLATION SCHEME
INSTALLATIONSANWEISUNG

