

# INCASSO VASCA CON PIASTRA, SCATOLA DI PROTEZIONE, SUPPORTO DOCCIA E DEVIATORE

CONCEALED BATH MIXER WITH PLATE, PROTECTION BOX, SHOWER BRACKET AND DIVERTER

EINBAUBADEWANNE MIT PLATTE, SCHUTZGEHÄUSE, DUSCHHALTERUNG UND UMSTELLVENTIL



**Art. 800/Q**

Verisone quadra con bocca quadra  
Square version with square spout  
Quadratische Ausführung mit quadratischem Auslauf



**Art. 800/R**

Verisone quadra con bocca rettangolare  
Square version with rectangular spout  
Quadratische Ausführung mit rechteckigem Auslauf

## ACCESSORI / ACCESSORIES / ZUBEHÖRTEILE

**Art. 1113**

Anello sede cartuccia  
Cartridge ring seat  
Kartuschenringsitz



**Art. 2905SFQ**

Deviatore 2 vie bordovasca automatico  
Deck diverter 2 ways automatic  
Automatisches 2-Wege-Umstellventil für Wannenrandarmaturen

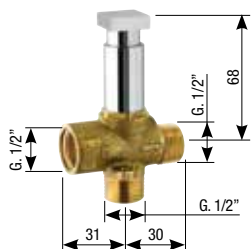

**Art. 1003SF**

Cappuccio ABS  
ABS cap  
ABS-Kappe

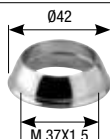

**Art. 1004BS**

Ghiera  
Ring nut  
Gewindehülse



**Art. 2006**

Anello fissaggio  
Fixing ring  
Haltering

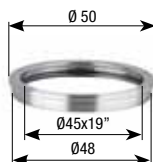

**Art. 1000**

Riduttore per cartuccia Ø 35 ABS  
Cartridge reduction Ø 35  
ABS-Kartuschenverminderung Ø 35



**Art. 270**

Supporto doccia  
Shower holder  
Duschhalterung

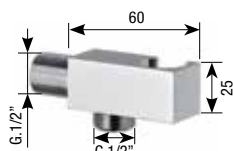

**Art. 1174**

Corpo miscelatore lavabo da incasso  
Concealed basin mixer  
body only  
Mischbatterie-Einbaukörper für Waschtische

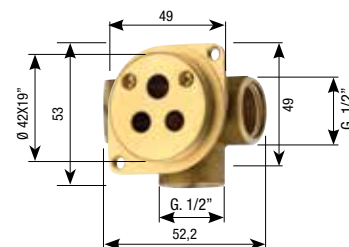

**Art. 801**

Scatola incasso fissaggio L.330  
Concealed fixing box L.330  
Gehäuse für die Einbaubefestigung L.330

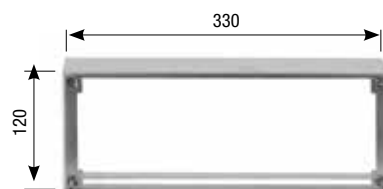

**Art. 804**

Piastra 340x130x2  
Plate 340x130x2  
Platte aus Chrom 340x130x2

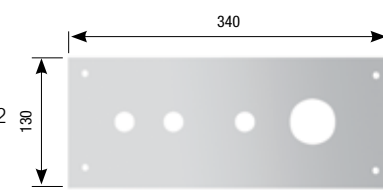

**Art. 808**

Tappo coprivite  
Screw cover  
Schraubenabdeckungsstopfen



**Art. 342**

Bocca quadrata  
Square spout  
Quadratischer Auslauf

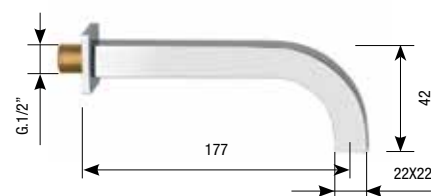

**Art. 341**

Bocca rettangolare  
Rectangular spout  
Rechteckiger Auslauf

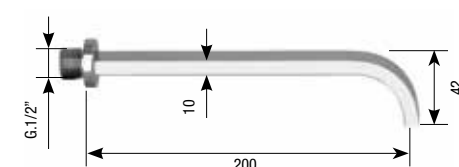

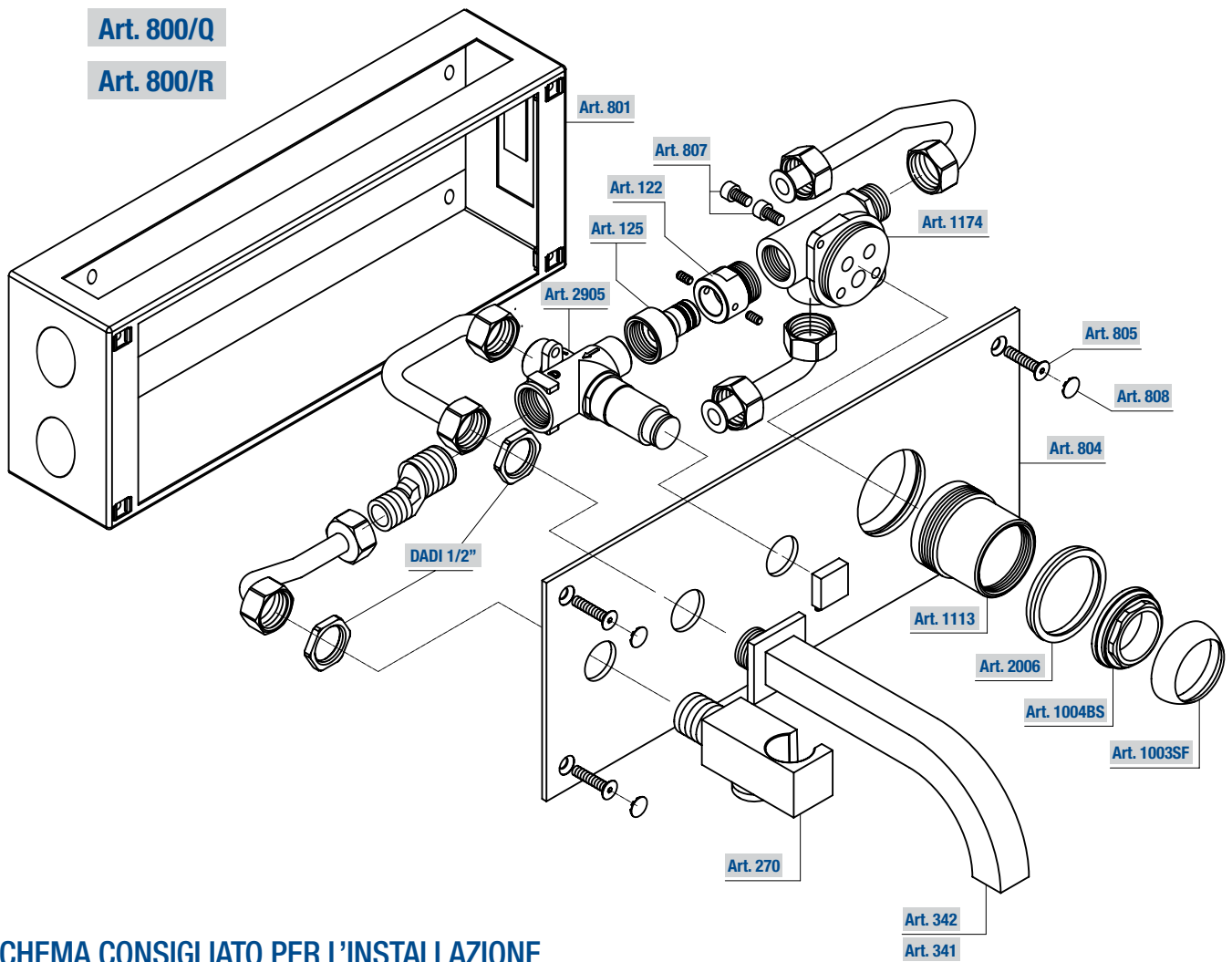

**SCHEMA CONSIGLIATO PER L'INSTALLAZIONE**  
**INSTALLATION SCHEME**  
**INSTALLATIONSANWEISUNG**

