

INCASSO LAVABO CON PIASTRA E SCATOLA DI PROTEZIONE

CONCEALED BASIN MIXER WITH PLATE AND PROTECTION BOX

EINBAUWASCHTISCH MIT PLATTE UND SCHUTZGEHÄUS



Art. 810/Q

Verisone quadra con bocca quadra
 Square version with square spout
 Quadratische Ausführung mit quadratischem Auslauf



Art. 810/R

Verisone quadra con bocca rettangolare
 Square version with rectangular spout
 Quadratische Ausführung mit rechteckigem Auslauf

ACCESSORI / ACCESSORIES / ZUBEHÖRTEILE

Art. 1113

Anello sede cartuccia
 Cartridge ring seat
 Kartuschenringsitz



Art. 1003SF

Cappuccio ABS
 ABS cap
 ABS-Kappe

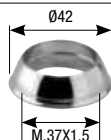

Art. 1004BS

Ghiera
 Ring nut
 Gewindehülse



Art. 2006

Anello fissaggio
 Fixing ring
 Haltering



Art. 1000

Riduttore per cartuccia Ø 35 ABS
 Cartridge reduction Ø 35
 ABS-Kartuschenverminderung Ø 35



Art. 1174

Corpo miscelatore
 lavabo da incasso
 Concealed basin mixer
 body only
 Mischbatterie-Einbaukörper
 für Waschtische

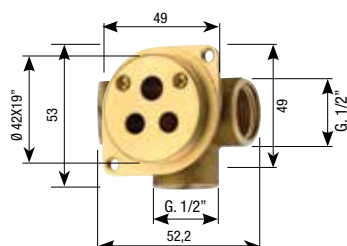

Art. 811

Scatola incasso
 fissaggio L.260
 Concealed fixing box L.260
 Gehäuse für die
 Einbaubefestigung L.260

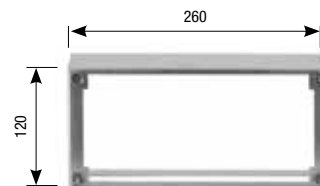

Art. 814

Piastra 270x130x2
 Plate 270x130x2
 Platte aus Chrom 270x130x2

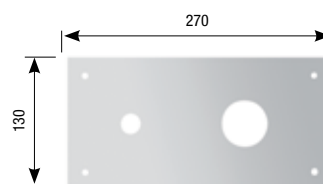

Art. 808

Tappo coprivite
 Screw cover
 Schraubenabdeckungsstopfen



Art. 342

Bocca quadrata
 Square spout
 Quadratischer Auslauf

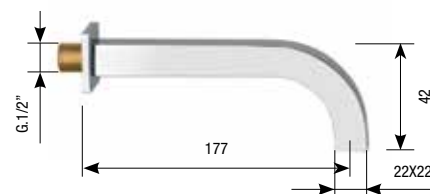

Art. 341

Bocca rettangolare
 Rectangular spout
 Rechteckiger Auslauf

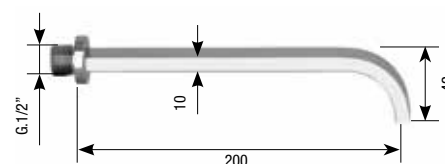

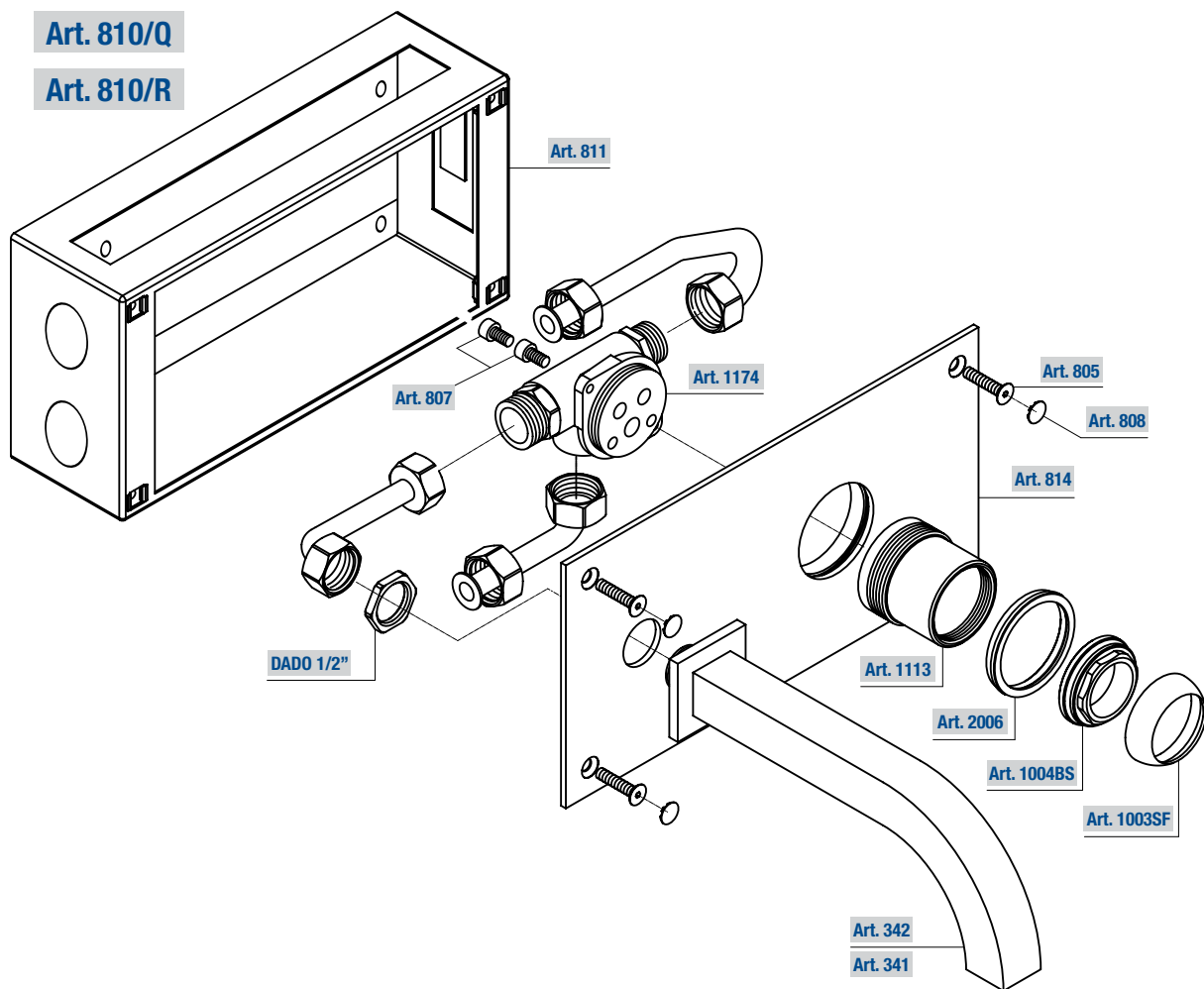

SCHEMA CONSIGLIATO PER L'INSTALLAZIONE
 INSTALLATION SCHEME
 INSTALLATIONSANWEISUNG

