

Art. 1180

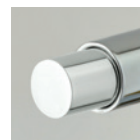

Art. 1180Q

versione quadrata
square version
Quadratische Ausführung



Art. 1180/MN

versione minimal
minimal design version
Minimalistische Ausführung
ottone cromato o ABS
brass-chrome or ABS
Verchromtes Messing oder ABS

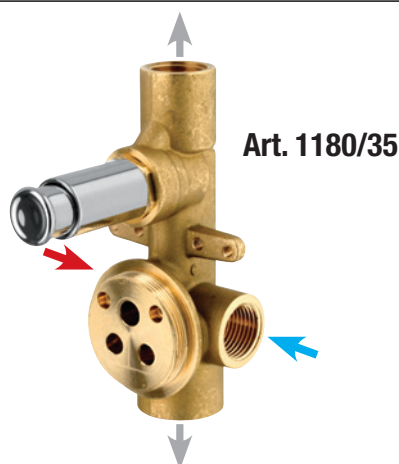
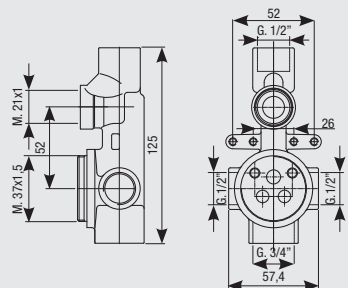

Art. 1180/35



Art. 1180/35Q

versione quadrata
square version
Quadratische Ausführung



Art. 1180/35MN

versione minimal
minimal design version
Minimalistische Ausführung
ottone cromato o ABS
brass-chrome or ABS
Verchromtes Messing oder ABS

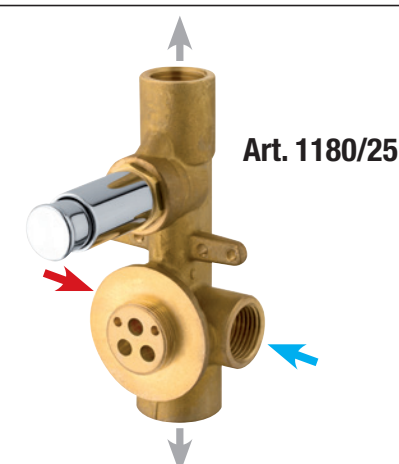
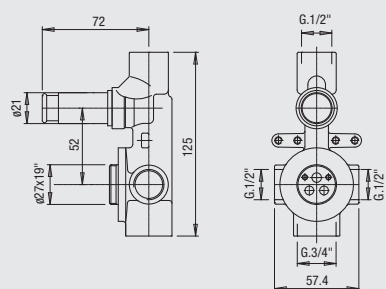

Art. 1180/25



Art. 1180/25Q

versione quadrata
square version
Quadratische Ausführung



Art. 1180/25MN

versione minimal
minimal design version
Minimalistische Ausführung
ottone cromato o ABS
brass-chrome or ABS
Verchromtes Messing oder ABS

Diagramma di portata (uscita libera)

Flow diagram (free exit)

Diagramm der Durchflussleistung (freier Ausgang)

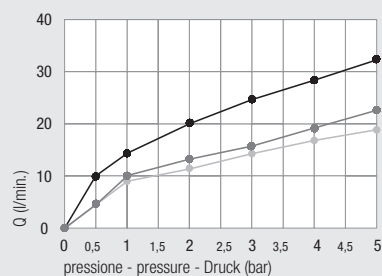

● vasca *bath* Badewanne ø 40 - ø 35
● doccia *shower* Dusche ø 40 - ø 35
● ø 25

Pistre idonee - *Appropriate plates* - Passende Platten (pag. 82-83)











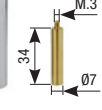





Art. 1180/35 Art. 1182... - 1192... - 1192/P... - 1030CA - 1186... - 1182/P...

Art. 1180 Art. 1183... - 1193/P... - 1193... - 1187... - 1040CA - 1183/P...

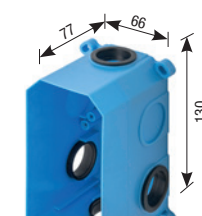
Art. 1180/25 Art. 1192/P25CA

- Disponibile in DZR
- Available in DZR brass
- Erhältlich in DZR

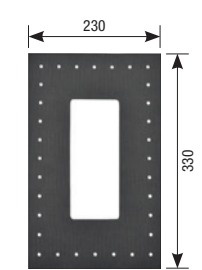
Accessori - *Accessories* - Zubehörteile

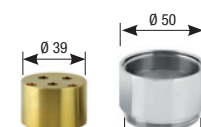
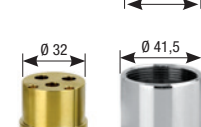
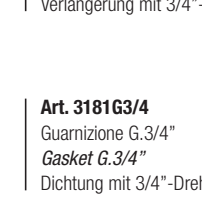
- | | | | |
|---|---|--|--|
| <p>Art. 1161
Anello sede cartuccia
<i>Cartridge ring seat</i>
Kartuschenringsitz</p> |  <p>M.42x19
M.45x19
Ø 50</p> | <p>Art. 610
Prolunga deviatore
<i>Diverter extension</i>
Verlängerung Umstellventil</p> |  <p>Ø 21
67
34
M.3
Ø 7</p> |
| <p>Art. 1013/35
Anello sede cartuccia
<i>Cartridge ring seat</i>
Kartuschenringsitz</p> |  <p>M.37x1,5
M.37x1,5
Ø 41,5</p> | <p>Art. PR50
Protezione mix
<i>Mix protection</i>
Schutzvorrichtung Mixer</p> |  <p>Ø 50</p> <p>Art. PR20
Protezione in plastica
<i>Plastic protection</i>
Kunststoffschutzvorrichtung</p>  |
| <p>Art. 1013/25
Anello sede cartuccia
<i>Cartridge ring seat</i>
Kartuschenringsitz</p> |  <p>M.27x1
M.27x1
Ø 29</p> | <p>Art. PR42
Protezione mix
<i>Mix protection</i>
Schutzvorrichtung Mixer</p> |  <p>Ø 42</p> <p>Art. PR29
Protezione mix
<i>Mix protection</i>
Schutzvorrichtung Mixer</p>  <p>Ø 29</p> |
| <p>Art. 1500
Cappuccio ABS
<i>ABS cap</i>
ABS-Kappe</p> |  <p>Ø 50
M.45x19"</p> | <p>Art. 1180PRPOL
Protezione in polistirolo
<i>Polystyrene protection</i>
Polystyrolschutzvorrichtung</p> |  |
| <p>Art. 1003SF
Cappuccio ABS
<i>ABS cap</i>
ABS-Kappe</p> |  <p>Ø 42
M.37x1,5</p> | <p>Art. 3181CG
Scatola di assemblaggio System box
<i>Multipurpose assembling box System box</i>
Montagegehäuse System box</p> |  <p>77
66
130</p> |
| <p>Art. 1003/25
Cappuccio ABS
<i>ABS cap</i>
ABS-Kappe</p> |  <p>Ø 29
M.27x1</p> | <p>Art. 3183
Coperchio scatola
<i>Box cover</i>
Gehäuseabdeckung</p> |  |
| <p>Art. 1501
Ghiera serraggio
<i>Ring nut</i>
Gewindeverschraubung</p> |  <p>M.45x19"</p> | <p>Art. 3181ME
Membrana isolante
<i>Insulating membrane</i>
Isolierungsmembran</p> |  <p>230
330</p> |
| <p>Art. 1004BS
Ghiera
<i>Ring nut</i>
Gewindehülse</p> |  <p>M.37x1,5</p> | <p>Art. 3185
Prolunga G.1/2"
<i>extension G.1/2"</i>
Verlängerung mit 1/2"-Drehung</p> | <p>Art. 3186
Prolunga G.3/4"
<i>extension G.3/4"</i>
Verlängerung mit 3/4"-Drehung</p> |
| <p>Art. 1004/25
Ghiera
<i>Ring nut</i>
Gewindehülse</p> |  <p>M.27x1</p> | <p>Art. 3181G1/2
Guarnizione G.1/2"
<i>Gasket G.1/2"</i>
Dichtung mit 1/2"-Drehung</p> | <p>Art. 3181G3/4
Guarnizione G.3/4"
<i>Gasket G.3/4"</i>
Dichtung mit 3/4"-Drehung</p> |
| <p>Art. 600
Kit prolunga sede cartuccia
<i>Extension kit for cartridge seat</i>
Verlängerungsbausatz Kartuschensitz</p> |  <p>Ø 39
Ø 50
M.45x19</p> | <p>Art. 600/35
Kit prolunga sede cartuccia
<i>Extension kit for cartridge seat</i>
Verlängerungsbausatz Kartuschensitz</p> | <p>Art. 600/25
Kit prolunga sede cartuccia
<i>Extension kit for cartridge seat</i>
Verlängerungsbausatz Kartuschensitz</p> |
| <p>Art. 600/35
Kit prolunga sede cartuccia
<i>Extension kit for cartridge seat</i>
Verlängerungsbausatz Kartuschensitz</p> |  <p>Ø 32
Ø 41,5
M.37x1,5</p> | <p>Art. 600/25
Kit prolunga sede cartuccia
<i>Extension kit for cartridge seat</i>
Verlängerungsbausatz Kartuschensitz</p> |  <p>Ø 25
Ø 29
M.27x19</p> |