

Ø40 **3 exits**

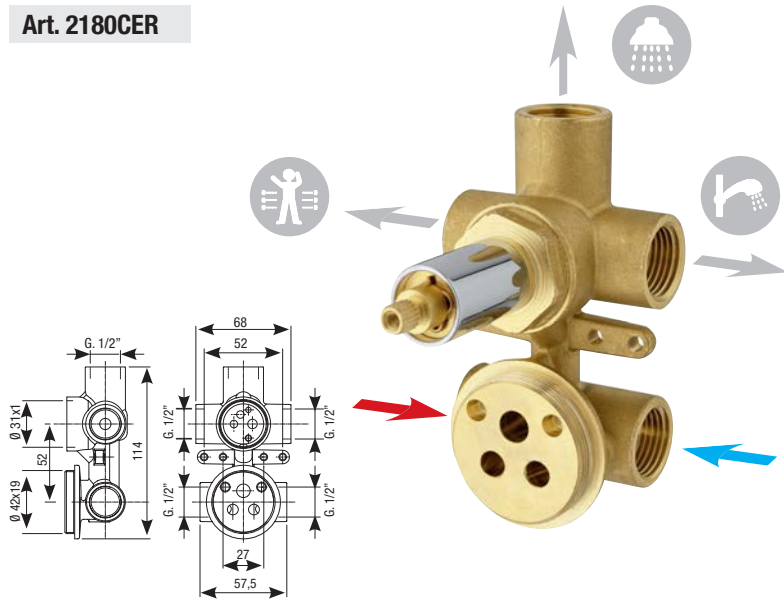

con deviatore **ceramico**
with **ceramic diverter**
Keramik-Umstellventil

Art. 2180CER



Art. 2190CER

Con bicchiere
With cartridge ring seat
Mit Kartuschenringsitz

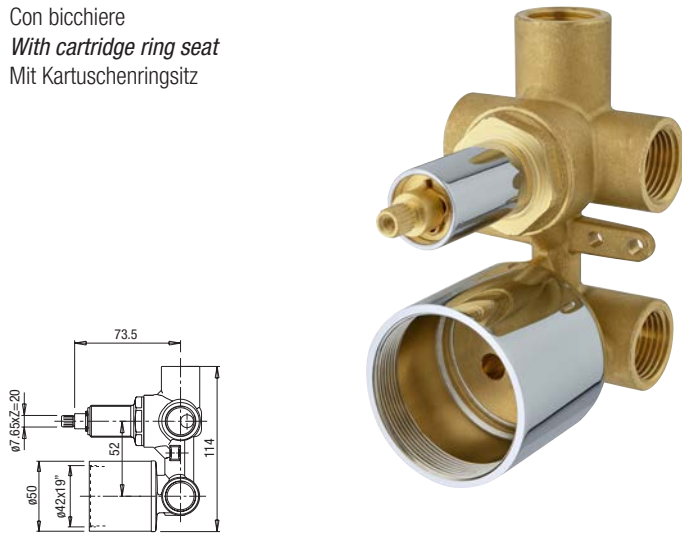

Art. 1161
Anello sede cartuccia
Cartridge ring seat
Kartuschenringsitz



Art. 1500
Cappuccio ABS
ABS cap
ABS-Kappe



Art. 1501
Ghiera serraggio
Ring nut
Gewindeverschraubung

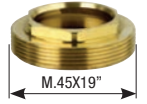

Art. 600
Kit prolunga sede cartuccia
Extension kit for cartridge seat
Verlängerungsbausatz Kartuschensitz

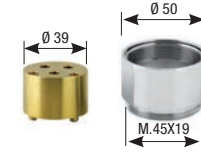

Art. 610
Prolunga deviatore
Diverter extension
Verlängerung Umstellventil

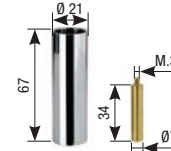

Art. 00122
Maniglia deviatore
Diverter handle
Umstellgriff

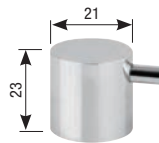

Art. 1502PRO
Coprifiletto deviatore cromato
Diverter cover thread
Verchromte Gewindeabdeckung Umstellventil

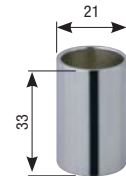

Art. PR50
Protezione mix
Mix protection
Schutzvorrichtung Mixer



Art. PR20
Protezione in plastica
Plastic protection
Kunststoffschutzvorrichtung



Art. 3182CG (pag. 101)
Scatola di assemblaggio
Multipurpose assembling box
Montagegehäuse

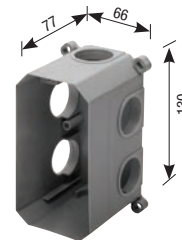

Art. 3183
Coperchio scatola
Box cover
Gehäuseabdeckung



Art. 3181ME
Membrana isolante
Insulating membrane
Isolierungsmembran

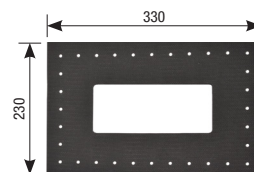

Art. 3185
Prolunga G.1/2"
Extension G.1/2"
Verlängerung mit 1/2"-Drehung



Art. 3181G1/2
Guarnizione G.1/2"
Gasket G.1/2"
Dichtung mit 1/2"-Drehung

