

Art. 2174

cartuccia \varnothing 40 - *cartridge \varnothing 40* - Kartusche \varnothing 40

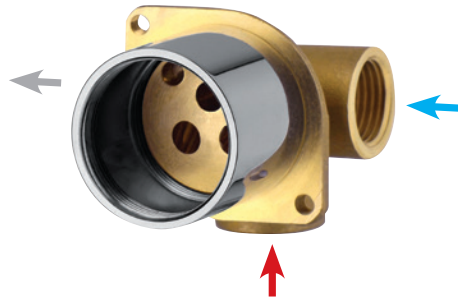
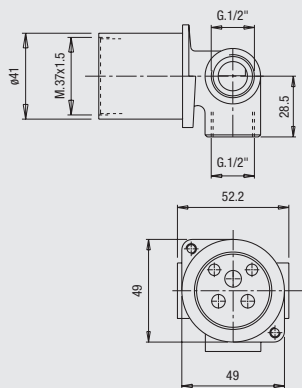

Art. 2174/35

cartuccia \varnothing 35 - *cartridge \varnothing 35* - Kartusche \varnothing 35

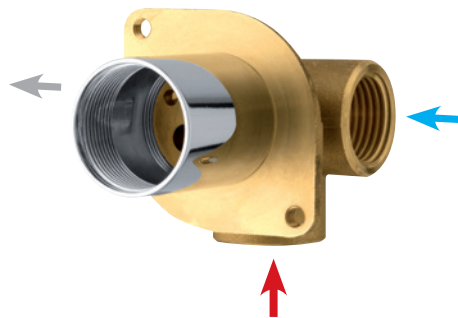
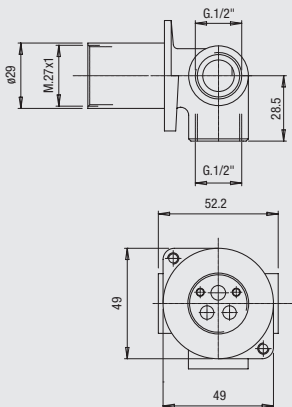

Art. 2174/25

cartuccia \varnothing 25 - *cartridge \varnothing 25* - Kartusche \varnothing 25

Diagramma di portata (uscita libera)

Flow diagram (free exit)

Diagramm der Durchflussleistung (freier Ausgang)

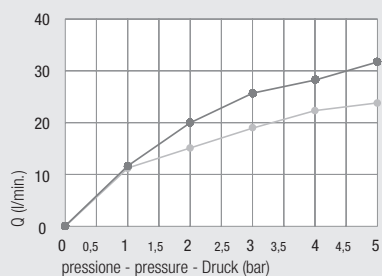

— \varnothing 40 - \varnothing 35
— \varnothing 25

Pistre idonee - *Appropriate plates* - Passende Platten (pag. 82-83)

Art. 2174 Art. 1196... - 1197... - 1188... - 1240CA - 1060CA

Art. 2174/35 Art. 1194... - 1198... - 1002... - 1235CA - 1050CA

Art. 2174/25 Art. 1002/25CA - 1225CA

Accessori - *Accessories* - Zubehörteile

Art. 1161
Anello sede cartuccia
Cartridge ring seat
Kartuschenringsitz



Art. 1013/35
Anello sede cartuccia
Cartridge ring seat
Kartuschenringsitz



Art. 1013/25
Anello sede cartuccia
Cartridge ring seat
Kartuschenringsitz



Art. 1500
Cappuccio ABS
ABS cap
ABS-Kappe



Art. 1003SF
Cappuccio ABS
ABS cap
ABS-Kappe



Art. 1003/25
Cappuccio ABS
ABS cap
ABS-Kappe



Art. 1501
Ghiera serraggio
Ring nut
Gewindeverschraubung

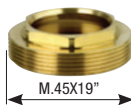

Art. 1004BS
Ghiera
Ring nut
Gewindehülse



Art. 1004/25
Ghiera
Ring nut
Gewindehülse



Art. 600
Kit prolunga sede cartuccia
Extension kit for cartridge seat
Verlängerungsbausatz Kartuschenring

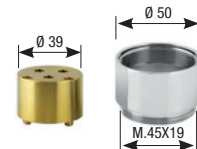

Art. 600/35
Kit prolunga sede cartuccia
Extension kit for cartridge seat
Verlängerungsbausatz Kartuschenring

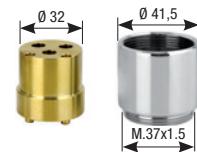

Art. 600/25
Kit prolunga sede cartuccia
Extension kit for cartridge seat
Verlängerungsbausatz Kartuschenring

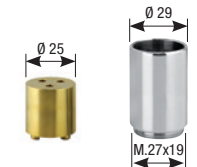

Art. PR50
Protezione mix
Mix protection
Schutzvorrichtung Mixer



Art. PR42
Protezione mix
Mix protection
Schutzvorrichtung Mixer



Art. PR29
Protezione mix
Mix protection
Schutzvorrichtung Mixer



Art. 1160PRPOL
Protezione
Protection
Schutzvorrichtung

