

Deviatore ceramico

Ceramic diverter

Keramik-Umstellventil

DZR
Available

ACS

WRAS

KTW

Diagramma di portata
(uscita libera)

Flow diagram
(free exit)

Diagramm der
Durchflussleistung
(freier Ausgang)

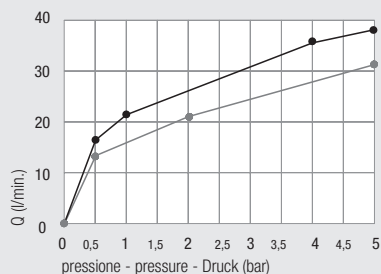

● uscita vasca - *bath exit* - Ausgang Badewanne
● uscita doccia - *shower exit* - Ausgang Dusche

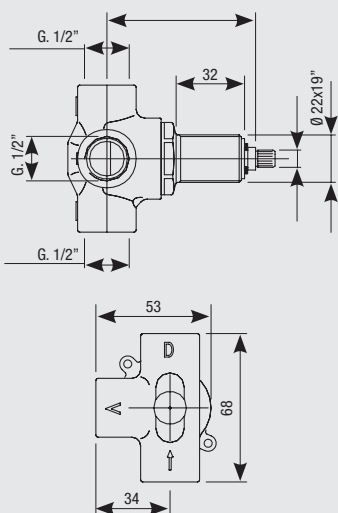

X **Y**

72	BR. Ø 7,65 x Z=20 BR. Ø 8 x Z=24
83,5	BR. Ø 7,65 x Z=20 BR. Ø 8 x Z=24
92	BR. Ø 7,65 x Z=20 BR. Ø 8 x Z=24
112,5	BR. Ø 7,65 x Z=20 BR. Ø 8 x Z=24

2
exits

1 entrata, 2 uscite
1 entrée, 2 exits
1 Eingang, 2 Ausgänge

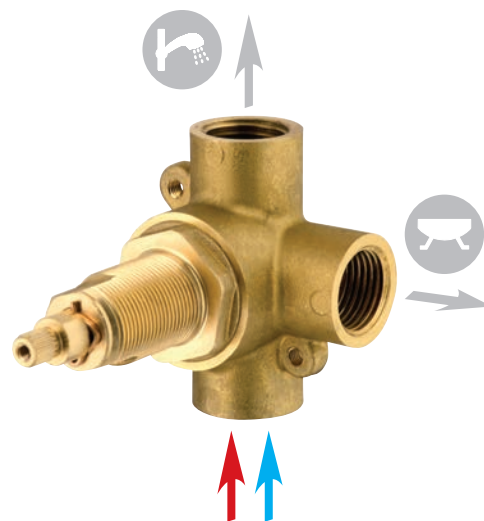

Art. 2207

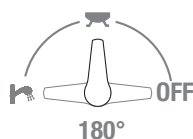

Art. 2207/90



Art. 00120
Maniglia deviatore
Diverter handle
Umstellgriffn

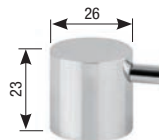

Adattatore
Ring adaptor
Adapter
Art. 2501 A Ø 26x19"
Art. 2502 A Ø 27x19"
Art. 2504 A G.3/4"



Art. 00080
Coprifiletto deviatore cromato
Diverter cover thread
Verchromte Gewindeabdeckung
für das Umstellventil

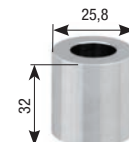

Art. PR22/19
Protezione coprifiletto
Thread protection
Gewindeabdeckungsschutz

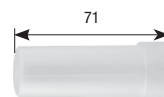

Art. 3188
Scatola di assemblaggio
Multipurpose assembling box
Montagegehäuse

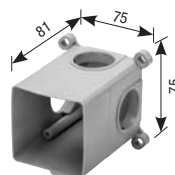

Art. 3189
Coperchio scatola
Box cover
Gehäuseabdeckung

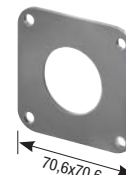

Art. 3188ME
Membrana isolante
Insulating membrane
Isolierungsmembran



Art. 3181G1/2
Guarnizione G.1/2"
Gasket G.1/2"
Dichtung mit
1/2"-Drehung



Art. 00097GU3
Tappo ø 33 mm
Plug ø 33 mm
Stopfen ø 33 mm

