



Art. 810
Bocca tonda
Round spout
Runde Auslauf



Art. 810/Q
Bocca quadrata
Square spout
Quadratischem Auslauf

Accessori - Accessories - Zubehörteile

Art. 1113

Anello sede cartuccia
Cartridge ring seat
Kartuschenringsitz



Art. 1003SF

Cappuccio ABS
ABS cap
ABS-Kappe



Art. 1004BS

Ghiera
Ring nut
Gewindehülse



Art. 2006

Anello fissaggio
Fixing ring
Haltering

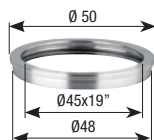

Art. 1000

Riduttore per cartuccia Ø 35 ABS
Cartridge reduction Ø 35
ABS-Kartuschenverminderung Ø 35



Art. 1174

Corpo miscelatore lavabo da incasso
Concealed basin mixer body only
Mischbatterie-Einbaukörper für Waschtische

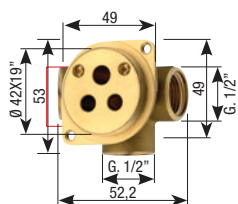

Art. 808

Tappo coprivite
Screw cover
Schraubenabdeckungsstopfen



Art. 811

Scatola incasso fissaggio L.260
Concealed fixing box L.260
Gehäuse für die Einbaubefestigung L.260

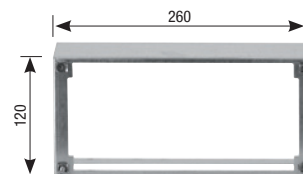

Art. 814

Piastra 270x130x2
Plate 270x130x2
Platte aus Chrom 270x130x2

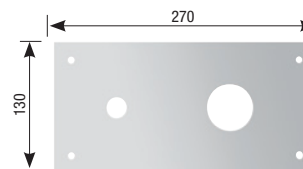

Art. 834

Piastra 270x130x2
Plate 270x130x2
Platte aus Chrom 270x130x2

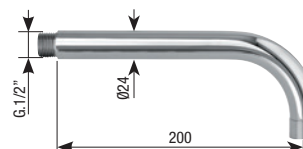

Art. 340

Bocca tonda
Round spout
Runde Auslauf

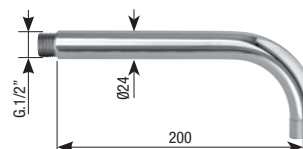

Art. 342

Bocca quadrata
Square spout
Quadratischer Auslauf

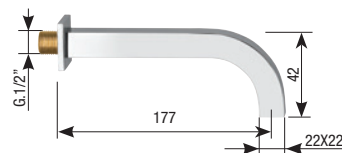

Art. 341

Bocca rettangolare
Rectangular spout
Rechteckiger Auslauf

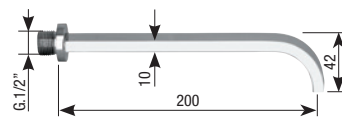

Art. 343

Bocca cascata
Waterfall spout
Kaskadenauslauf

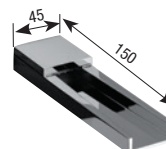

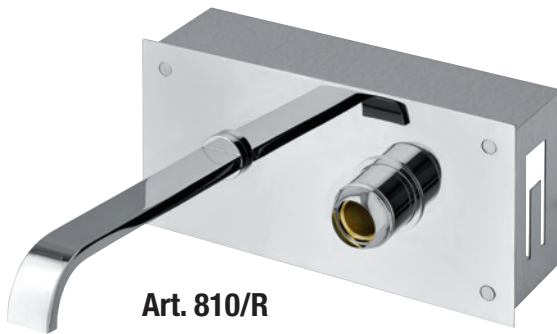

Art. 810/R

Bocca rettangolare
Rectangular spout
Rechteckigem Auslauf



Art. 810/W

Bocca cascata
Waterfall spout
Kaskadenauslauf

Schema consigliato per l'installazione
Installation scheme
Installationsanweisung

