

MISCELATORE DOCCIA INCASSO A 2/3 USCITE Ø 35

CONCEALED SHOWER MIXER 2/3 EXITS Ø 35

EINBAU-MISCHBATTERIE FÜR DUSCHEN MIT 2/3 AUSGÄNGEN Ø 35



Art. 2180/35

Art. 2180/35Q

versione quadrata
square version
Quadratische Ausführung



Art. 2180/35MN

versione minimal
minimal design version
Minimalistische Ausführung



Art. 2190/35

Art. 2190/35Q

versione quadrata
square version
Quadratische Ausführung



Art. 2190/35MN

versione minimal
minimal design version
Minimalistische Ausführung



- Possibilità di produzione in DZR
- Possible to be produced in DZR brass
- Möglichkeit für eine Produktion in DZR

FUNZIONALITÀ FUNCTIONS FUNKTIONSTÄTIGKEITEN



Diagramma di portata (uscita libera)
Flow diagram (free exit)
Diagramm der Durchflussleistung (freier Ausgang)

USCITA DOCCIA
SHOWER EXIT
AUSGANG DUSCHE

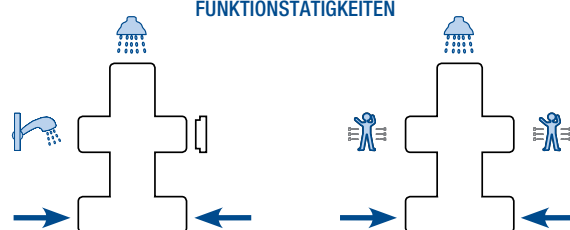
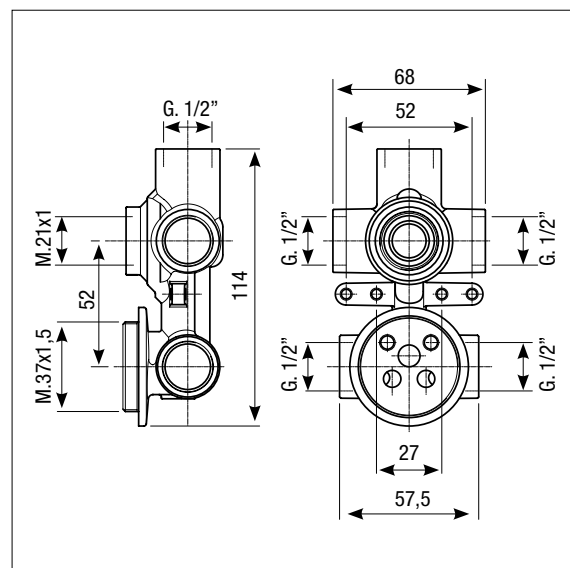
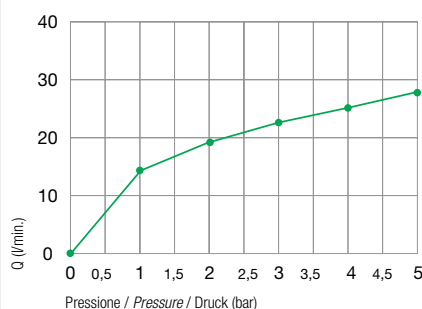

Piastre idonee (vedi pag. 93)
Appropriate plates (page 93)
 Passende Platten (pag. 93)

Art. 1182 - 1192 - 1192/P - 1030CA - 1186 - 1182/P

ACCESSORI / ACCESSORIES / ZUBEHÖRTEILE

Art. 1013/35

Anello sede cartuccia
Cartridge ring seat
 Kartuschenringsitz



Art. 1003SF

Cappuccio ABS
ABS cap
 ABS-Kappe

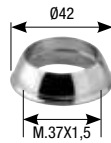

Art. 1004BS

Ghiera
Ring nut
 Gewindehülse
 M.37x1,5

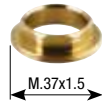

Art. 600/35

Kit prolunga sede cartuccia
Extension kit for cartridge seat
 Verlängerungsbausatz Kartuschensitz



Art. 610

Prolunga deviatore
Diverter extension
 Verlängerung Umstellventil

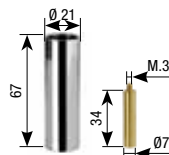

Art. PR20

Protezione in plastica
Plastic protection
 Kunststoffschutzvorrichtung



Art. 2180PRPOL

Protezione in polistirolo
Polystyrene protection
 Polystyrolschutzvorrichtung



Art. PR42

Protezione mix
Mix protection
 Schutzvorrichtung Mixer



Art. 00097

Scatola di assemblaggio
System box
 Multipurpose assembling box
System box
 Montagegehäuse
System box

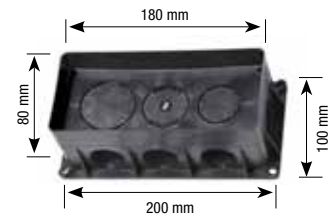

Art. 00097ME

Membrana isolante
 330x230 mm
Insulating membrane
 330x230 mm
 Isoliermembran
 330x230 mm



Art. 00097GU1

Anello gomma foro 25,2 mm (3/4")
O-ring 3/4"
 Gummiring mit einer Bohrung
 von 25,2 mm (3/4")



Art. 00097GU2

Anello gomma foro 19 mm (1/2")
O-ring 1/2"
 Gummiring mit einer Bohrung
 von 19 mm (1/2")



Art. 00097GU3

Tappo Ø 33 mm
Plug Ø 33 mm
 Stopfen Ø 33 mm

