

# MIX DOCCIA INCASSO A 2/3 USCITE Ø 35 - DEVIATORE CERAMICO

CONCEALED SHOWER MIXER 2/3 EXITS Ø 35 - CERAMIC DIVERTER

EINBAU-MISCHBATTERIE FÜR DUSCHEN MIT 2/3 AUSGÄNGEN Ø 35 – KERAMIK-UMSTELLVENTIL

Art. 2180/35CER

Art. 2190/35CER



- Possibilità di produzione in DZR
- Possible to be produced in DZR brass
- Möglichkeit für eine Produktion in DZR

FUNZIONALITÀ  
FUNCTIONS  
FUNKTIONSTÄTIGKEITEN



Diagramma di portata (uscita libera)  
Flow diagram (free exit)  
Diagramm der Durchflussleistung (freier Ausgang)

USCITA DOCCIA  
SHOWER EXIT  
AUSGANG DUSCHE

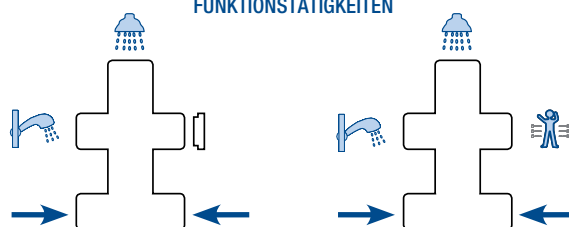
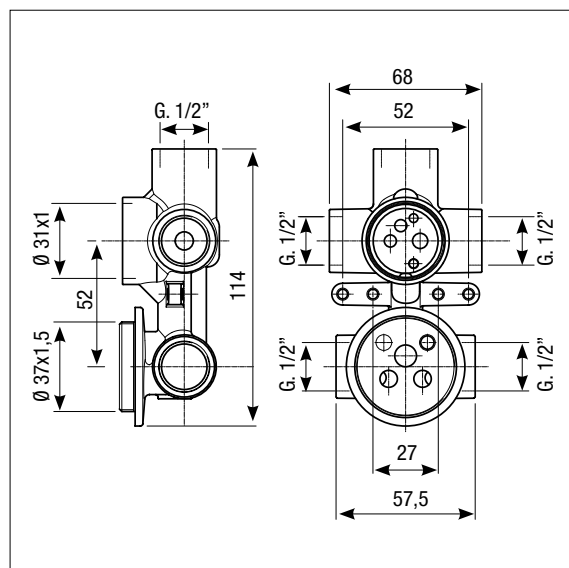
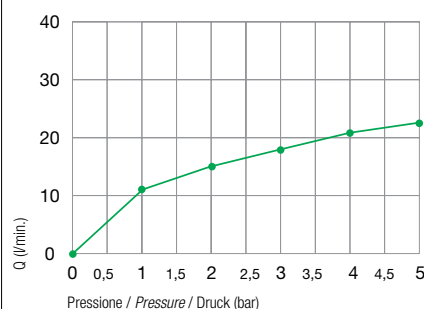

Piastre idonee (vedi pag. 93)  
*Appropriate plates (page 93)*  
 Passende Platten (pag. 93)

**Art. 1182 - 1192 - 1192/P - 1030CA - 1186 - 1182/P**

ACCESSORI / ACCESSORIES / ZUBEHÖRTEILE

**Art. 1013/35**

Anello sede cartuccia  
*Cartridge ring seat*  
 Kartuschenringsitz



**Art. 1003SF**

Cappuccio ABS  
*ABS cap*  
 ABS-Kappe

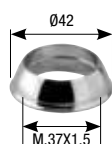

**Art. 1004BS**

Ghiera  
*Ring nut*  
 Gewindehülse  
 M.37x1,5



**Art. 600/35**

Kit prolunga sede cartuccia  
*Extension kit for cartridge seat*  
 Verlängerungsbausatz Kartuschensitz



**Art. 630**

Prolunga deviatore  
*Diverter extension*  
 Verlängerung Umstellventil

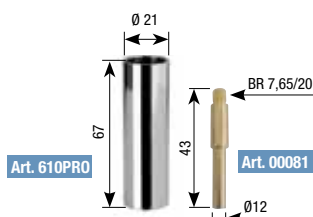

**Art. 00122**

Maniglia deviatore  
*Diverter handle*  
 Umstellgriff



**Art. 1502PRO**

Coprifiletto deviatore cromato  
*Diverter cover thread*  
 Verchromte Gewindeabdeckung  
 Umstellventil

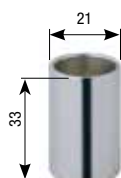

**Art. 2180PRPOL**

Protezione in polistirolo  
*Polystyrene protection*  
 Polystyrolschutzvorrichtung



**Art. 00097**

Scatola di assemblaggio  
*System box*  
 Multipurpose assembling box  
*System box*  
 Montagegehäuse  
 System box

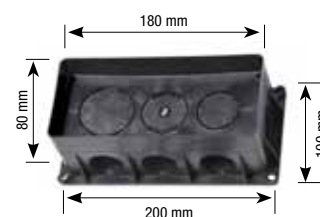

**Art. 00097ME**

Membrana isolante  
 330x230 mm  
*Insulating membrane*  
 330x230 mm  
 Isoliermembran  
 330x230 mm



**Art. 00097GU1**

Anello gomma foro 25,2 mm (3/4")  
*O-ring 3/4"*  
 Gummiring mit einer Bohrung  
 von 25,2 mm (3/4")



**Art. 00097GU2**

Anello gomma foro 19 mm (1/2")  
*O-ring 1/2"*  
 Gummiring mit einer Bohrung  
 von 19 mm (1/2")



**Art. 00097GU3**

Tappo Ø 33 mm  
*Plug Ø 33 mm*  
 Stopfen Ø 33 mm

