

MISCELATORE DA INCASSO Ø 35

CONCEALED MIXER Ø 35

EINBAU-MISCHBATTERIE Ø 35

Art. 1175/35

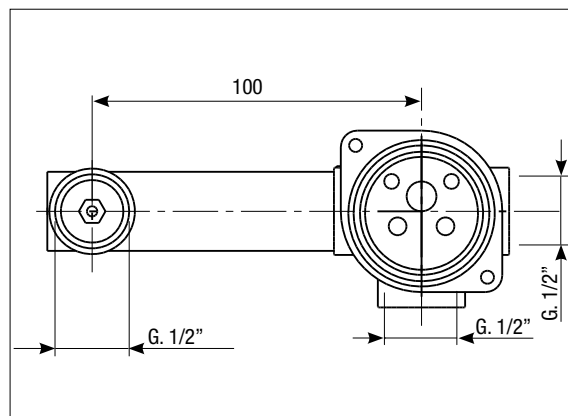
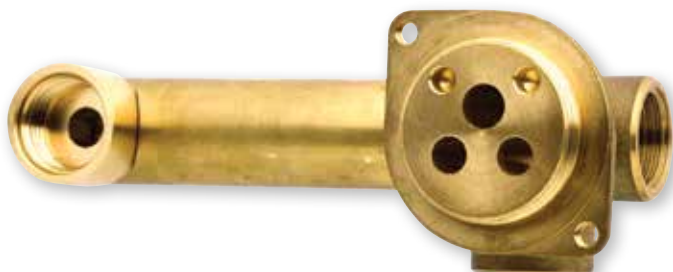

Art. 1023/269

Miscelatore doccia incasso completo di scatola di montaggio "system box" (pag. 70)

Built-in shower mixer with assembly box "system box" (page 70)

Einbaudusche, vervollständigt mit Montagegehäuse - "System box" (pag. 70)



Art. 1023/340

Miscelatore lavabo incasso completo di scatola di montaggio "system box" (pag. 70)

Concealed basin mixer with assembly box "system box" (page 70)

Einbauwaschtisch, vervollständigt mit Montagegehäuse - "System box" (pag. 70)



ACCESSORI / ACCESSORIES / ZUBEHÖRTEILE

Art. 1013/35

Anello sede cartuccia
Cartridge ring seat
Kartuschenringsitz



Art. 00050

Anello fissaggio piastra per miscelatore
Plate fixing ring - mixer
Plattenbefestigungsring für Mischbatterie



Art. 00030

Anello per bocca erogazione
Spout ring
Ring für Auslauf



Art. 00110

Anello per supporto
Shower holder ring
Ring für Halterung

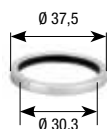

Art. 269

Supporto doccia
Shower holder
Duschhalterung

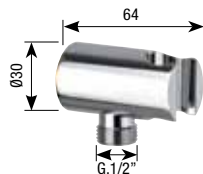

Art. 269COD

Prolunga G. 1/22
Extension
Verlängerung G. 1/22

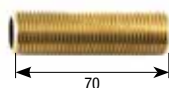

Art. 00097

Scatola di assemblaggio
System box
Multipurpose assembling box
System box
Montagegehäuse - System box



Art. 1003SF

Cappuccio ABS
ABS cap
ABS-Kappe

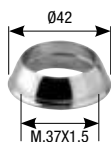

Art. 1004BS

Ghiera
Ring nut
Gewindehülse
M.37x1,5



Art. 340

Bocca
Spout
Auslauf

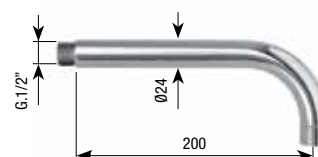

Art. 1023

Piastra cromata
Chromed plate
Verchromte Platte

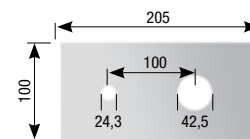

Art. 00097ME

Membrana isolante
330x230 mm
Insulating membrane
330x230 mm
Isolierungsmembran
330x230 mm



Art. 00097GU1

Anello gomma foro 25,2 mm (3/4")
O-ring 3/4"
Gummiring mit einer Bohrung
von 25,2 mm (3/4")



Art. 00097GU2

Anello gomma foro 19 mm (1/2")
O-ring 1/2"
Gummiring mit einer Bohrung
von 19 mm (1/2")



Art. 00097GU3

Tappo ø 33 mm
Plug ø 33 mm
Stopfen ø 33 mm

