

# MISCELATORE DA INCASSO Ø 35 CON DEVIATORE CERAMICO

CONCEALED MIXER CARTRIDGE Ø 35 WITH CERAMIC DIVERTER

EINBAU-MISCHBATTERIE Ø 35 MIT KERAMIK-UMSTELLVENTIL

## Art. 401

Corpo doccia con deviatore 3 vie  
*Shower mixer with 3 ways  
ceramic diverter*  
Duschkörper mit 3-Wege-Umstellventil



## Art. 402

Corpo doccia con deviatore 2 vie  
*Shower mixer with 2 ways  
ceramic diverter*  
Duschkörper mit 2-Wege-Umstellventil



## Art. 403

Corpo doccia con deviatore 2 vie  
*Shower mixer with 2 ways  
ceramic diverter*  
Duschkörper mit 2-Wege-Umstellventil



## Art. 1024/401

completo di scatola di montaggio  
"system box" (pag. 70)

## Art. 1024/402

with assembly box  
"system box" (page 70)

## Art. 1024/403

vervollständigt mit Montagegehäuse  
- "System box" (pag. 70)

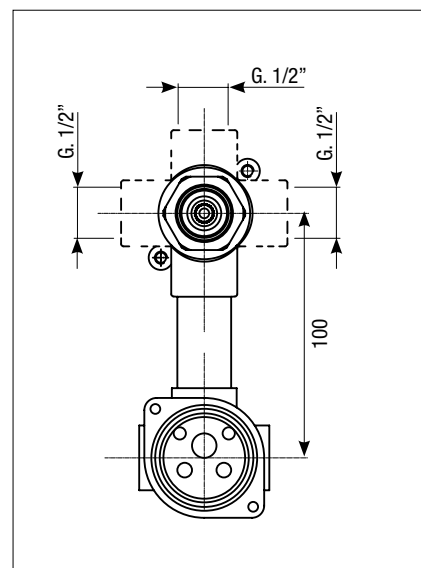

ACCESSORI / ACCESSORIES / ZUBEHÖRTEILE

**Art. 1013/35**

Anello sede cartuccia  
Cartridge ring seat  
Kartuschenringsitz



**Art. 00050**

Anello fissaggio piastra per miscelatore  
Plate fixing ring - mixer  
Plattenbefestigungsring für Mischbatterie



**Art. 00120**

Maniglia deviatore  
Diverter handle  
Umstellgriff

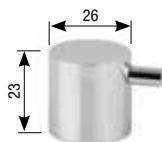

**Art. 00080**

Coprifiletto deviatore cromato  
Diverter cover thread  
Verchromte Gewindeabdeckung  
Umstellventil



**Art. 00040**

Anello fissaggio piastra per deviatore  
Plate fixing ring - diverter  
Plattenbefestigungsring für Umstellventil

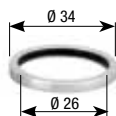

**Art. 00097**

Scatola di assemblaggio  
System box  
Multipurpose assembling box  
System box  
Montagegehäuse - System box

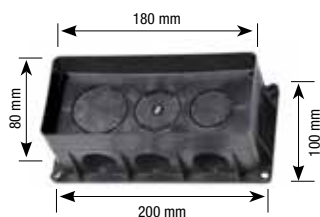

**Art. 1003SF**

Cappuccio ABS  
ABS cap  
ABS-Kappe

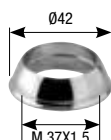

**Art. 1004BS**

Ghiera  
Ring nut  
Gewindehülse  
M.37x1,5

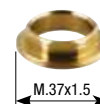

**Art. 1024**

Piastra cromata  
Chromed plate  
Verchromte Platte

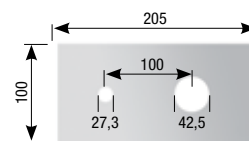

**Art. 00097ME**

Membrana isolante  
330x230 mm  
Insulating membrane  
330x230 mm  
Isolierungsmembran  
330x230 mm



**Art. 00097GU1**

Anello gomma foro 25,2 mm (3/4")  
O-ring 3/4"  
Gummiring mit einer Bohrung  
von 25,2 mm (3/4")



**Art. 00097GU2**

Anello gomma foro 19 mm (1/2")  
O-ring 1/2"  
Gummiring mit einer Bohrung  
von 19 mm (1/2")



**Art. 00097GU3**

Tappo ø 33 mm  
Plug ø 33 mm  
Stopfen ø 33 mm

