

MISCELATORE DA INCASSO Ø 35 CON DEVIATORE

CONCEALED MIXER CARTRIDGE Ø 35 WITH DIVERTER

EINBAU-MISCHBATTERIE Ø 35 MIT UMSTELLVENTIL

Art. 407

Corpo doccia con deviatore 3 vie
Shower mixer with 3 ways ceramic diverter
Duschkörper mit 3-Wege-Umstellventil



Art. 408

Corpo doccia con deviatore 2 vie
Shower mixer with 2 ways ceramic diverter
Duschkörper mit 2-Wege-Umstellventil



Art. 409

Corpo doccia con deviatore 2 vie
Shower mixer with 2 ways ceramic diverter
Duschkörper mit 2-Wege-Umstellventil

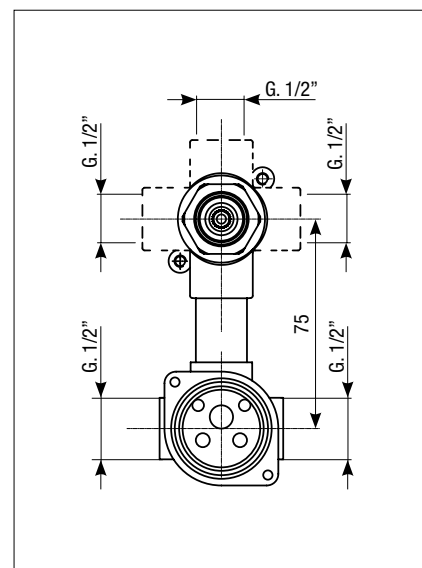

Art. 1018/407

Art. 1018/408

Art. 1018/409



Art. 1017/407

Art. 1017/408

Art. 1017/409



ACCESSORI / ACCESSORIES / ZUBEHÖRTEILE

Art. 1017

Piastra cromata
Chromed plate
Verchromte Platte

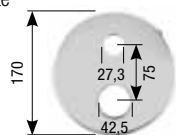

Art. 1018

Piastra cromata
Chromed plate
Verchromte Platte

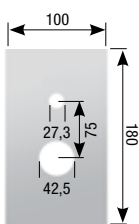

Art. 1013/35

Anello sede cartuccia
Cartridge ring seat
Kartuschenringsitz



Art. 00050

Anello fissaggio piastra per miscelatore
Plate fixing ring - mixer
Plattenbefestigungsring für Mischbatterie

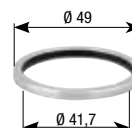

Art. 00120

Maniglia deviatore
Diverter handle
Umstellgriff

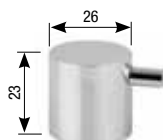

Art. 1003SF

Cappuccio ABS
ABS cap
ABS-Kappe

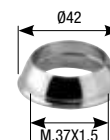

Art. 00080

Coprifiletto deviatore cromato
Diverter cover thread
Verchromte Gewindeabdeckung
Umstellventil



Art. 1004BS

Ghiera
Ring nut
Gewindehülse

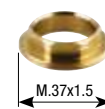

Art. 00040

Anello fissaggio piastra per deviatore
Plate fixing ring - diverter
Plattenbefestigungsring für Umstellventil

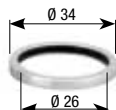

Art. 475PRPOL

Protezione in polistirolo
Polystyrene protection
Polystyrolschutzvorrichtung

