

Miscelatore termostatico doccia incasso con deviatore

Concealed thermostatic shower mixer with diverter

Eingebaute thermostatische Mischbatterie für Duschen mit einem Umstellventil



pressione - pressure - Druck **3 bar**

65.00°C	10.57 l/m
38.67°C	24.33 l/m
18.05°C	13.76 l/m

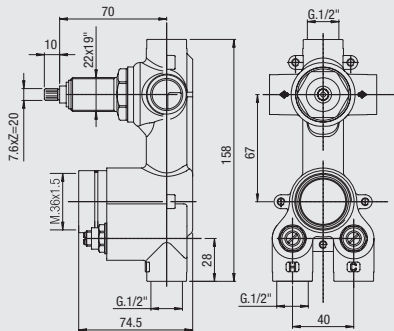

Piastrre idonee - Appropriate plates - Passende Platten

Art. 8014 CA

Piastra 115x200 mm
anelli ottone cromato
*Plate 115x200 mm
chrome-plated brass rings*
Platte aus Chrom 115x200 mm
Ringe aus verchromten Messing

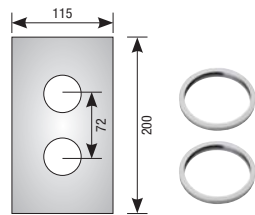

Art. 8015 CA

Piastra 130x230 mm
anelli ottone cromato
*Plate 130x230 mm
chrome-plated brass rings*
Platte aus Chrom 130x230 mm
Ringe aus verchromten Messing

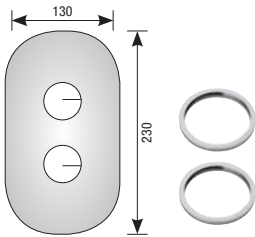

Art. 8016 CA

Piastra 115x200 mm
anelli ottone cromato
*Plate 115x200 mm
chrome-plated brass rings*
Platte aus Chrom 115x200 mm
Ringe aus verchromten Messing

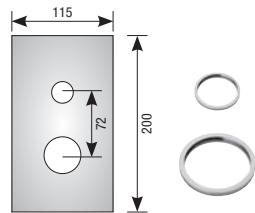

Art. 8017 CA

Piastra 130x230 mm
anelli ottone cromato
*Plate 130x230 mm
chrome-plated brass rings*
Platte aus Chrom 130x230 mm
Ringe aus verchromten Messing

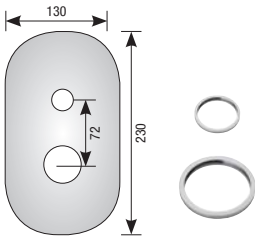

1 way



Art. 8000A1

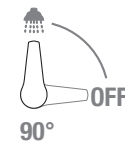

2 exits



Art. 8000A2

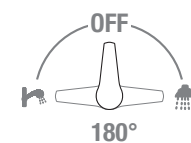

3 exits



Art. 8000A3

Art. 8000A3/3

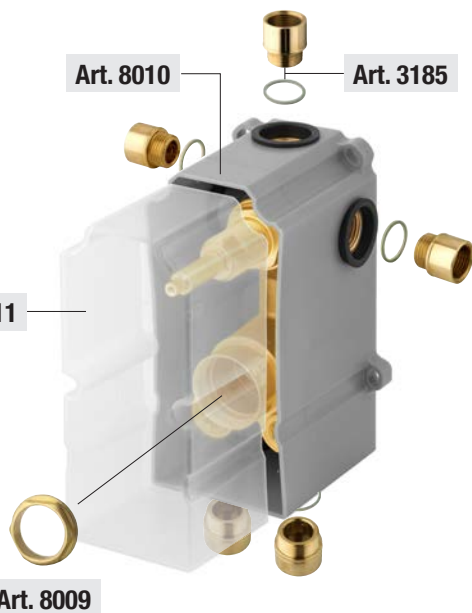
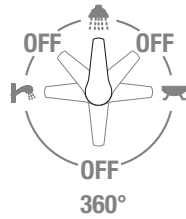
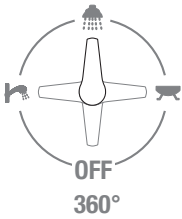

Art. 8012
Anello ottone cromato
Chrome-plated brass ring
Ring aus verchromten Messing

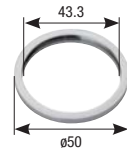

Art. 00040
Anello fissaggio piastra per deviatore
Plate fixing ring - diverter
Plattenbefestigungsring für Umstellventil



Art. 8002
Anello per cartuccia termostatica
Ring for thermostatic cartridge
Ring für Thermostatkartusche

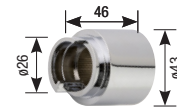

Art. 8003
Anello per deviatore
Ring for diverter
Ring für Umstellventil

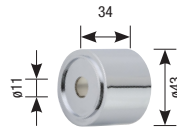

Art. 8007
Anello per art. 8003
Ring for art. 8003
Ring für 8003



Art. 00120
Maniglia deviatore
Diverter handle
Umstellgriff

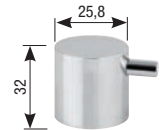

Art. 00080
Coprifiletto deviatore cromato
Diverter cover thread
Verchromte Gewindeabdeckung Umstellventil

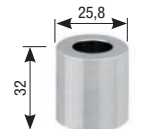

Art. 8013
Membrana isolante
Insulating membrane
Isolierungsmembran

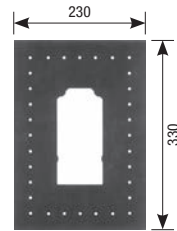

Art. 8010
Scatola di assemblaggio
System box
Multipurpose assembling box
System box
Montagegehäuse
System box

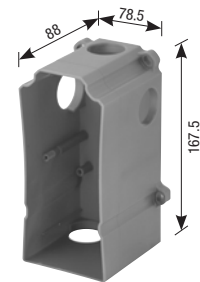

Art. 8011
Coperchio scatola
Box cover
Gehäuseabdeckung



Art. 3185
Prolunga G.1/2"
Extension G.1/2"
Verlängerung mit 1/2"-Drehung



Art. 3181G1/2
Guarnizione G.1/2"
Gasket G.1/2"
Dichtung mit 1/2"-Drehung



Art. 8009
Ghiera serraggio
Ring nut
Gewindeverschraubung

