

Collettore Manifold Kollektor

6
exits

NPT
Available

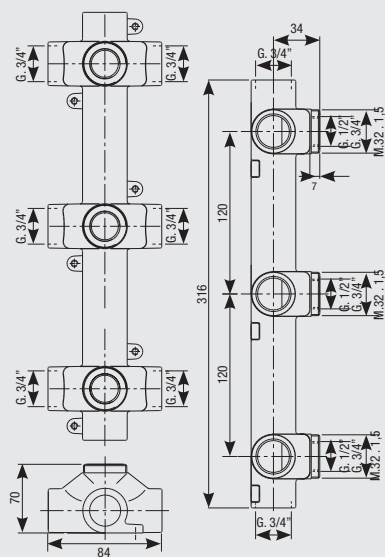

Art. 7000A

Con vitone 1/2"
With 1/2" headwork
Mit Oberteil 1/2"

Art. 7000

Con vitone 3/4"
With 3/4" headwork
Mit Oberteil 3/4"



Art. 1080/7000A

Con vitone 1/2"
With 1/2" headwork
Mit Oberteil 1/2"

Art. 1080/7000

Con vitone 3/4"
With 3/4" headwork
Mit Oberteil 3/4"



Art. 00130

Anello fissaggio piastra vitone
Plate fixing ring - headwork
Plattenbefestigungsring für Oberteil

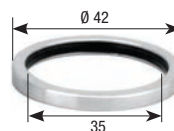

Art. 00140

Coprivitone
Headwork cover ring
Oberteilabdeckung



Art. 7000 SUP

Supporto h 9,4 mm
Bracket h 9,4 mm
Unterstützung h 9,4 mm



Art. 1080

Piastra cromata
Chromed plate
Verchromte Platte

